

Brunner Enterprises™ Inc.

Toll-Free (877) 299-2622; Fax (716) 826-3054

www.brunnerent.com

2015

for 1/4" material

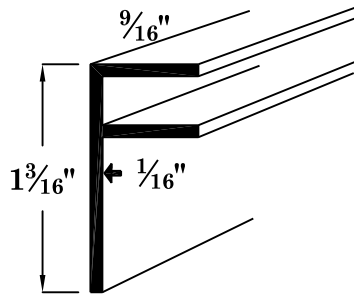

F250 S

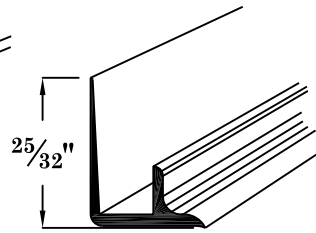

G853 S*

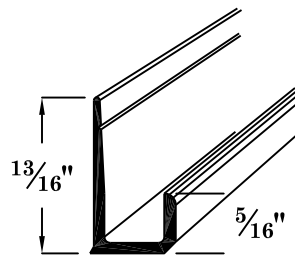

G851 S*,
SB** & GB*

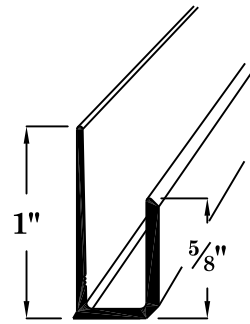

G1244 S*,
SB** & GB*

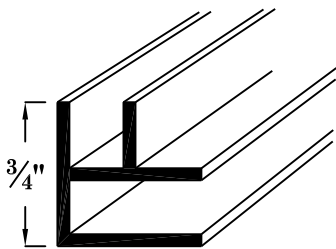

G250 S*

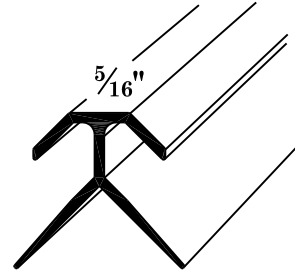

G852 S* & SL*

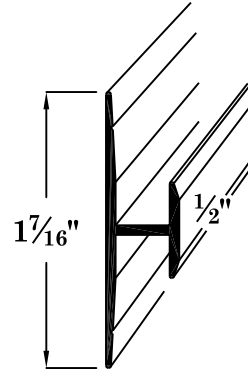

G850 S* & SB*

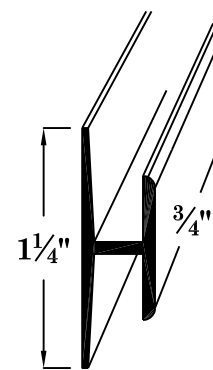

G849 S**

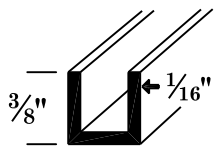

C20606 S**
12', 8', 6' & 4'

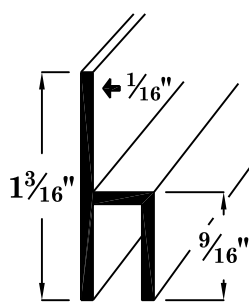

H250 S

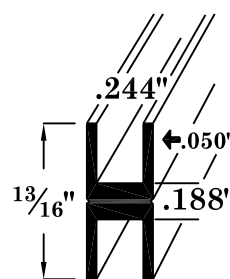

HU244 S**
for 1/4" plexi.

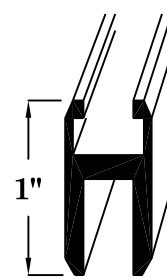

CL808 S*
for 1/4" signs

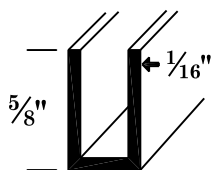

C21006 S**

Finishes:
S Satin Etch
SB Bright Silver
GB Bright Gold
SL Silver Luster
BR BRonze

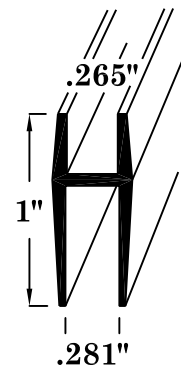

D2052 S*
Roller Shoe

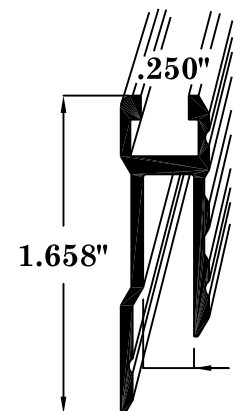

G2248 S*
for 1/4" signs
Recessed to Accept 1/16" Back Panel

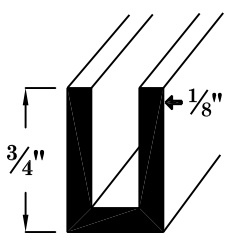

C41208 S**

Lengths:

24ft, 12ft, 8ft, 6ft & 4ft

* 12ft, 6ft & 4ft only

** 12ft, 8ft, 6ft & 4ft